

KENWOOD

KDC-5005
KDC-4005
KDC-3005
KDC-2006

CD-RECEIVER

INSTRUCTION MANUAL

AMPLI-TUNER LECTEUR DE CD

MODE D'EMPLOI

REPRODUTOR DE DISCOS COMPACTOS/RECEPTOR DE FM/AM

MANUAL DE INSTRUCCIONES

KENWOOD CORPORATION

Take the time to read through this instruction manual.

Familiarity with installation and operation procedures will help you obtain the best performance from your new CD-receiver.

For your records

Record the serial number, found on the back of the unit, in the spaces designated on the warranty card, and in the space provided below. Refer to the model and serial numbers whenever you call upon your KENWOOD dealer for information or service on the product.

Model KDC-5005/4005/3005/2006 Serial number _____

© B64-0646-30 (KW) (MC)

COMPACT
disc
DIGITAL AUDIO

Contents

Before use

Warning	3
Safety precautions	4
Handling Compact Discs	6
Features	8

Basic operations

Power	10
Volume	10
Attenuator	11
Loudness	11

Tuner operations

Tuning	12
Station Preset Memory	13
Auto Memory Entry	13
Clean Reception System Circuit (CRSC)	13

CD player operations

Playing CDs	14
Switching Display for CDs	15
Fast Forwarding and Reversing Disc Play	15
Track Search	15
Track Repeat	16
Track Scan	17
Random Play	17

Other operations

Audio Control Setting	18
Selectable Illumination	19
Switching Preout	19
Clock Display	20
Adjusting Time	20
Disabled System Indicator (DSI)	21
Theft Deterrent Faceplate	21

Installation

Accessories	22
Installation Procedure	23
Connecting Wires to Terminals	24
Installation	26

Troubleshooting Guide

Specifications

Warning

CAUTION

Use of controls or adjustments or performance of procedures other than those specified herein may result in hazardous radiation exposure. In compliance with Federal Regulations, following are reproductions of labels on, or inside the product relating to laser product safety.

KENWOOD CORPORATION
2967-3, ISHIKAWA-CHO,
HACHIOJI-SHI
TOKYO, JAPAN

KENWOOD CORP CERTIFIES THIS EQUIPMENT
CONFORMS TO DHHS REGULATIONS NO 21 CFR
1040.10, CHAPTER I, SUBCHAPTER J

Location : Bottom Panel

FCC WARNING

This equipment may generate or use radio frequency energy. Changes or modifications to this equipment may cause harmful interference unless the modifications are expressly approved in the instruction manual. The user could lose the authority to operate this equipment if an unauthorized change or modification is made.

NOTE

This equipment has been tested and found to comply with the limits for a Class B digital device, pursuant to Part 15 of the FCC Rules. These limits are designed to provide reasonable protection against harmful interference in a residential installation. This equipment may cause harmful interference to radio communications, if it is not installed and used in accordance with the instructions. However, there is no guarantee that interference will not occur in a particular installation. If this equipment does cause harmful interference to radio or television reception, which can be determined by turning the equipment off and on, the user is encouraged to try to correct the interference by one or more of the following measures:

- Reorient or relocate the receiving antenna.
- Increase the separation between the equipment and receiver.
- Connect the equipment into an outlet on a circuit different from that to which the receiver is connected.
- Consult the dealer or an experienced radio/TV technician for help.

Before use

Basic operations

Tuner features

CD player features

Other features

NOTE

This Class B digital apparatus meets all requirements of the Canadian interference-Causing Equipment Regulations.

Safety precautions

▲WARNING

To prevent injury or fire, take the following precautions:

- Insert the unit all the way in until it is fully locked in place. Otherwise it may fall out of place when jolted.
- When extending the ignition, battery, or ground wires, make sure to use automotive-grade wires or other wires with a diameter of 0.75mm² or more to prevent wire deterioration and damage to the wire coating.
- To prevent a short circuit, never put or leave any metallic objects (such as coins or metal tools) inside the unit.
- If the unit starts to emit smoke or strange smells, turn off the power immediately and consult your Kenwood dealer.
- Be careful not to drop the unit or subject it to strong shock.
The unit may break or crack because it contains glass parts.
- Do not touch the liquid crystal fluid if the LCD is damaged or broken due to shock. The liquid crystal fluid may be dangerous to your health or even fatal. If the liquid crystal fluid from the LCD contacts your body or clothing, wash it off with soap immediately.

▲CAUTION

To prevent damage to the machine, take the following precautions:

- Make sure to ground the unit to a negative 12V DC power supply.
- Do not open the top or bottom covers of the unit.
- Do not install the unit in a spot exposed to direct sunlight or excessive heat or humidity. Also avoid places with too much dust or the possibility of water splashing.
- Do not set the removed faceplate or the faceplate case in areas exposed to direct sunlight, excessive heat, or humidity. Also avoid places with too much dust or the possibility of water splashing.
- Do not subject the faceplate to excessive shock, as it is a piece of precision equipment.
- To prevent deterioration, do not touch the terminals of the unit or faceplate with your fingers.
- When replacing a fuse, only use a new one with the prescribed rating. Using a fuse with the wrong rating may cause your unit to malfunction.
- To prevent a short circuit when replacing a fuse, first disconnect the wiring harness.
- Do not use your own screws. Use only the screws provided. If you use the wrong screws, you could damage the unit.

NOTE

- If you experience problems during installation, consult your Kenwood dealer.
- If the unit doesn't seem to be working right, try pressing the reset button first. If that does not fix the problem, consult your Kenwood dealer.

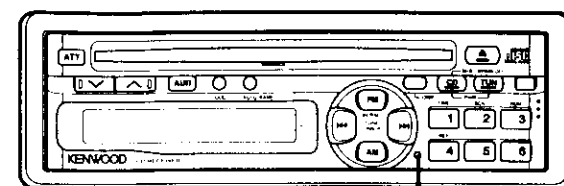

reset button

Safety precautions

Cleaning the Unit

If the front panel gets dirty, turn off the power and wipe the panel with a dry silicon cloth or soft cloth.

CAUTION

Do not wipe the panel with a hard cloth or a cloth dampened by volatile solvents such as paint thinner and alcohol. They can scratch the surface of the panel and/or cause the indicator letters to peel off.

Cleaning the Faceplate Terminals

If the terminals on the unit or faceplate get dirty, wipe them with a dry, soft cloth.

Cleaning the CD Slot

As dust tends to accumulate in the CD slot, clean it every once in a while. Your CDs can get scratched if you put them in a dusty CD slot.

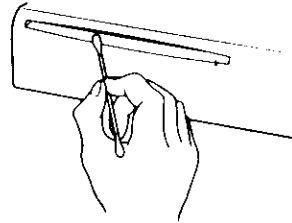

Lens Fogging

Right after you turn on the car heater in cold weather, dew or condensation may form on the lens in the CD player of the unit. Called lens fogging, CDs may be impossible to play. In such a situation, remove the disc and wait for the condensation to evaporate. If the unit still does not operate normally after a while, consult your Kenwood dealer.

Handling Compact Discs

Playing a CD that is dirty, scratched, or warped can cause the sound to skip and the unit to operate incorrectly, resulting in worsened sound quality. Take the following precautions to prevent your CDs from getting scratched or damaged.

Handling CDs

- Do not touch the recorded side of the CD (the side opposite the label) when holding it.

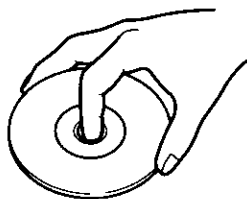

- Do not stick tape on either side of the CD.

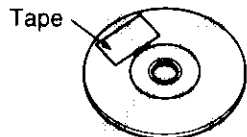

Storing CDs

- Do not store CDs in areas exposed to direct sunlight (such as a car seat or the dashboard) or other hot places.
- Remove CDs from the unit when not listening to them for a while, and put them back in their cases. Do not pile up CDs that are removed from their cases or prop them against something.

Cleaning CDs

If a CD has gotten dirty, wipe it off gently using a commercially available cleaning cloth or a soft cotton cloth, starting from the center of the disc and moving outward. Do not clean CDs with conventional record cleaners, anti-static formulas, or chemicals such as paint thinner or benzene.

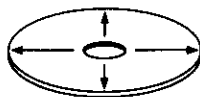

Checking New CDs for Burrs

When playing a new CD for the first time, check that there are not any burrs stuck to the perimeter of the disc or in the central hole. CDs with burrs stuck on them may not load properly or may skip while playing. Remove burrs using a ballpoint pen or a similar utensil.

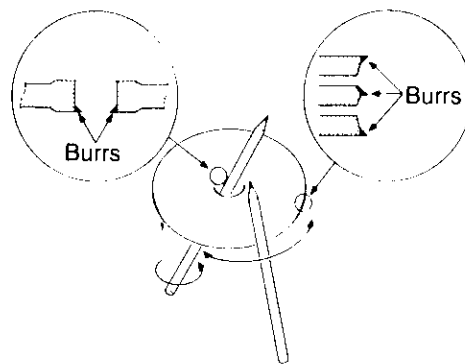

Do Not Load CD Accessories

Do not use commercially available CD accessories that can be loaded into the CD slot, such as stabilizers, protective sheets, or CD cleaning discs, since they can cause the unit to malfunction.

⚠ CAUTION

• Do Not Load 3-in. CDs in the CD slot

If you try to load a 3 in. CD with its adapter into the unit, the adapter might separate from the CD and damage the unit.

• Do Not Use Dirty CDs or CDs Colored on the Data Side

If you try to play CDs that are colored on the recorded side (the side opposite the label), or CDs that are dirty, the CD may fail to slide in or out.



Dear Customer:

Selecting fine audio equipment such as the unit you've just purchased is only the start of your musical enjoyment. Now it's time to consider how you can maximize the fun and excitement your equipment offers. This manufacturer and the Electronic Industries Association's Consumer Electronics Group want you to get the most out of your equipment by playing it at a safe level. One that lets the sound come through loud and clear without annoying blaring or distortion—and, most importantly, without affecting your sensitive hearing.

Sound can be deceiving. Over time your hearing "comfort level" adapts to higher volumes of sound. So what sounds "normal" can actually be loud and harmful to your hearing. Guard against this by setting your equipment at a safe level **BEFORE** your hearing adapts.

To establish a safe level:

- Start your volume control at a low setting.
- Slowly increase the sound until you can hear it comfortably and clearly, and without distortion.

Once you have established a comfortable sound level:

- Set the dial and leave it there.

Taking a minute to do this now will help to prevent hearing damage or loss in the future. After all, we want you listening for a lifetime.

We Want You Listening For A Lifetime

Used wisely, your new sound equipment will provide a lifetime of fun and enjoyment. Since hearing damage from loud noise is often undetectable until it is too late, this manufacturer and the Electronic Industries Association's Consumer Electronics Group recommend you avoid prolonged exposure to excessive noise. This list of sound levels is included for your protection.

Decible

<u>Level</u>	<u>Example</u>
30	Quiet library, soft whispers
40	Living room, refrigerator, bedroom away from traffic
50	Light traffic, normal conversation, quiet office
60	Air conditioner at 20 feet, sewing machine
70	Vacuum cleaner, hair dryer, noisy restaurant
80	Average city traffic, garbage disposals, alarm clock at two feet.

THE FOLLOWING NOISES CAN BE DANGEROUS UNDER CONSTANT EXPOSURE

90	Subway, motorcycle, truck traffic, lawn mower
100	Garbage truck, chain saw, pneumatic drill
120	Rock band concert in front of speakers, thunderclap
140	Gunshot blast, jet plane
180	Rocket launching pad

Information courtesy of the Deafness Research Foundation.



Features

■ Tuner

- **Auto seek tuning (p. 12)**
Conducts automatic seeks of receivable stations. Useful when you do not know the frequencies of particular stations.
- **Station preset memory (p. 13)**
Stores the frequency of the station currently being listened to. You can then recall that station with a single touch of a button. Useful for stations that you listen to often.
- **Auto memory entry (p. 13)**
Automatically stores all the receivable stations in the band currently being listened to. You can then recall those stations with a single touch of a button. Useful when you do not know the stations in the area in which you are traveling. Up to six stations can be stored with this function.
- **Clean Reception System Circuit (CRSC) (p. 13)**
When poor stereo reception occurs while you are listening to the tuner, this function temporarily switches from stereo to mono reception to reduce the level of noise.

■ CD player

- **Track search (p. 15)**
Moves (forward or reverse) by one track each time the button (▶▶| or ◀◀) is pressed, and plays that track from the beginning.
- **Track repeat (p. 16)**
Repeatedly plays the track currently being listened to.
- **Track scan (p. 17)**
Plays the first few seconds of each track on the CD, helping you find the track that you want to listen to.
- **Random play (p. 17)**
Plays all the tracks on the CD in random order.

■ Other

- **Attenuator (p. 11)**
Turns down the volume quickly.
- **Loudness control (p. 11)**
Amplifies low and high tones when the volume is turned down, for fuller sound quality.
- **Audio control setting (p. 18)**
Allows for adjustment of bass, treble, balance, and fader.
- **Selectable illumination (Function of the KDC-5005 / 4005) (p. 19)**
Switches the color of the display between green and amber.
- **Clock display (p. 20)**
Displays the time.
- **Theft deterrent faceplate (Function of the KDC-5005 / 4005 / 3005) (p. 21)**
The faceplate of the unit can be detached and taken with you as you leave the car, in order to deter theft.
- **Disabled system indicator (DSI) (Function of the KDC-5005 / 4005 / 3005) (p. 21)**
When this function is turned on, a red indicator will flash on the unit after the faceplate is removed, making it appear as if you have a security system operating in your car, warning potential thieves.
- **Switching preout (Function of the KDC-5005) (p. 19)**
The front preout can be switched to non-fading. When you select non-fading, the high-pass filter is automatically applied to the front and rear output, making this function convenient when using a sub-woofer connected to the system.

Basic operations

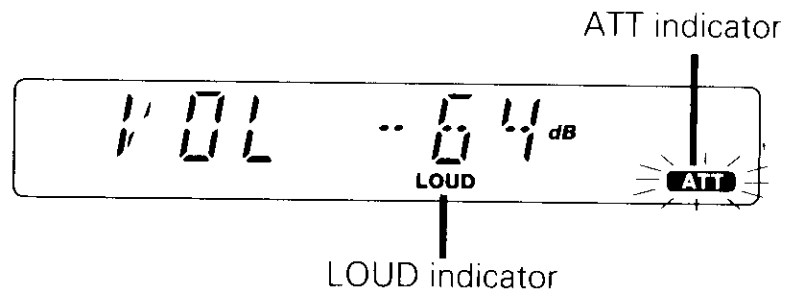
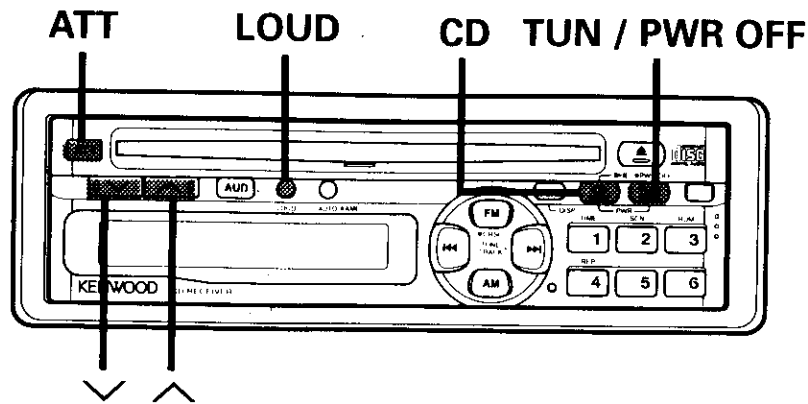

Power

Turning on the power:

Press either the CD or TUN button.

NOTE

Turn the power on before completing the following procedures.

Turning off the power:

Press the PWR OFF button for at least one second.

Selecting standby mode:

Press the TUN button repeatedly and switch to "OFF." When "OFF" is displayed, the standby mode is activated. The standby mode turns all functions off while leaving the power to the unit on. Use this mode when you want to have the display illuminated but don't want to listen to anything.

Volume

Increasing Volume:

Press the \wedge button to turn up the volume.

Decreasing Volume:

Press the \vee button to turn down the volume.

Attenuator

This function allows you to turn down the volume quickly.

Turning Attenuator On/Off:

Press the ATT button to switch the attenuator on and off. When the attenuator is on, the ATT indicator blinks. When the attenuator is off, the volume returns to the original level.

NOTE

Turning the volume all the way down deactivates the attenuator function.

Loudness

This function amplifies low and high tones when the volume is turned down.

Turning Loudness On/Off:

Press the LOUD button to switch the loudness on and off. The LOUD indicator lights up when the loudness function is on.

Tuner operations

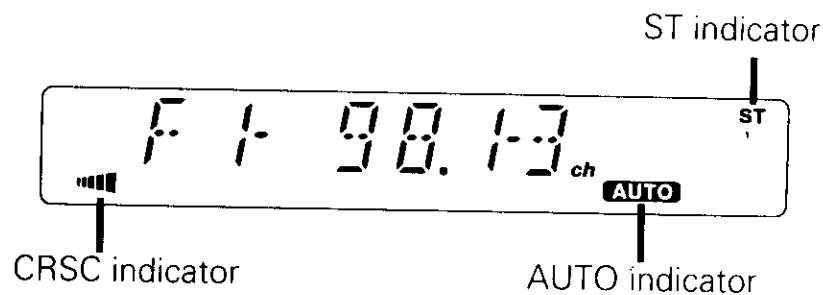
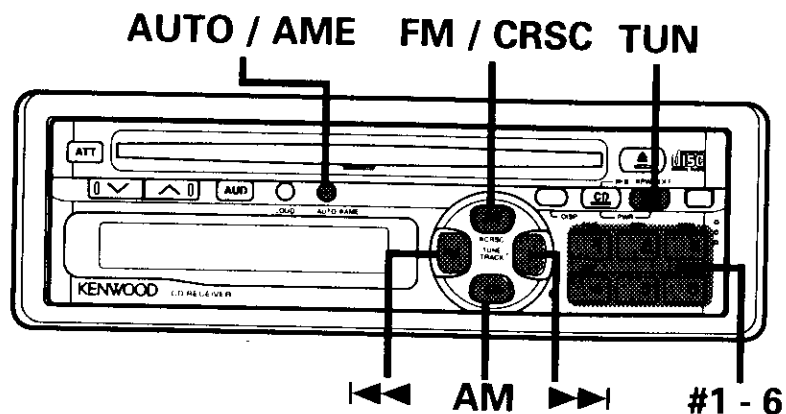

Tuning

- 1 Press the TUN button to turn the radio on.
- 2 Press either the FM or AM button to select the band. Each time you press the FM button, the band switches between FM1, FM2, and FM3 (which are used for groups of preset stations). Press the AM button to select the AM band.
- 3 Press the AUTO button to switch between auto seek tuning and manual tuning. The AUTO indicator lights up only when auto seek tuning is selected.
- 4
 - Auto Seek Tuning
Press the ►► button to seek higher frequencies.
Press the ◀◀ button to seek lower frequencies.
 - Manual Tuning
Press the ►► button to increase the frequency by one step.
Press the ◀◀ button to decrease the frequency by one step.

NOTE

The ST indicator lights up when stereo broadcasts are being received.

Station Preset Memory

Store the frequency of a station.

- 1 Select the band/frequency of the station that you want to have stored.
- 2 Press the button (#1-6) that you want to use for the station, for at least two seconds. The button number blinks once in the display to indicate that the data has been stored.

Recalling a Preset Station:

Press the preset station button (#1-6) for the desired station. The number of the recalled station is displayed.

NOTE

You can store six stations in each of the FM1, FM2, FM3, and AM bands.

Auto Memory Entry

Automatically store the receivable stations in the area.

- 1 Select the band for which you want to store stations.
- 2 Press the AME button for at least two seconds to start auto memory entry. The numbers of the preset station buttons are shown in order. When all the stations in a certain band are stored in the preset memory, the auto memory entry stops. The tuner then plays the last station received.

Recalling a Preset Station:

Press the preset station button (#1-6) for the desired station. The number of the recalled station is displayed.

Clean Reception System Circuit (CRSC)

Temporarily have reception switched from stereo to mono to reduce multi-path noise when listening to the tuner.

Turning CRSC On/Off:

Press the CRSC button for at least one second to turn the function on/off. The CRSC indicator lights up when CRSC is on.

NOTE

Strong electrical fields (such as from power lines) may cause unstable sound quality when CRSC is turned on. In such a situation, turn it off.

CD player operations

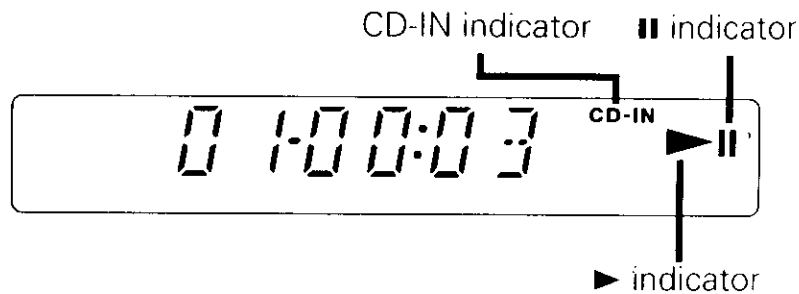
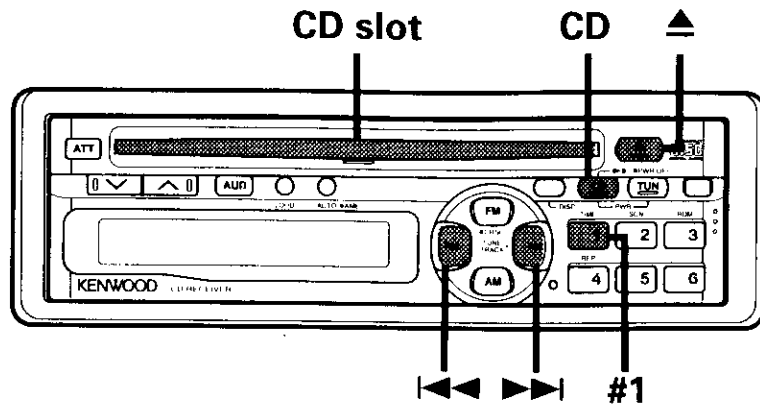

Playing CDs

Playing CDs:

If no CDs are inserted, insert one in the slot with the label facing up.

If a CD is already inserted, press the CD button.

The CD-IN indicator lights up when a CD has been inserted.

The ▶ indicator lights up when a CD is being played.

Pausing and Restarting CD Play:

Press the ▶|| button to make the disc pause. The || indicator lights up.

Press the same button again to start play again.

Stopping and Ejecting CDs:

Press the ▲ button.

The CD stops playing and ejects from the slot.

CAUTION

- Do not attempt to insert a CD into the slot if another one is already there.
- The unit can only play 5 in. CDs. If you insert a 3 in. CD, it will get stuck inside and can cause the unit to malfunction.
- Do not use CDs that are colored or dirty on the recorded side (the side opposite the label). They may cause malfunction, with the CD not being able to be inserted or ejected.

NOTE

When you load a CD and eject it right away, the next time you try to insert the CD may not load. In such a situation, take the CD out for a moment and then reinsert it.

Switching Display for CDs

Switch the display that appears while discs are playing.

Switching Display for CDs:

Each time you press button #1, the display during CD play switches as follows:

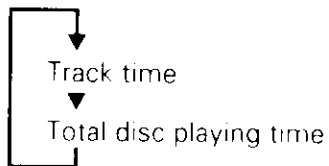

Track Search

Search forward or backward through the tracks on the disc until you reach the one that you want to listen to.

Making a Reverse Track Search:

Press the ◀◀ button to display the desired track number. Press once to search back to the beginning of the current track, twice to search back to the beginning of the previous track, and so forth. Play starts at the beginning of the displayed track number.

Making a Forward Track Search:

Press the ▶▶ button to display the desired track number. Press once to fast forward to the next track, twice to fast forward to the track after that, and so forth. Play starts at the beginning of the displayed track number.

Fast Forwarding and Reversing Disc Play

Fast Forwarding Disc Play:

Hold down on the ▶▶ button.
Release your finger to play the disc at that point.

Reversing Disc Play:

Hold down on the ◀◀ button.
Release your finger to play the disc at the point.

CD player operations

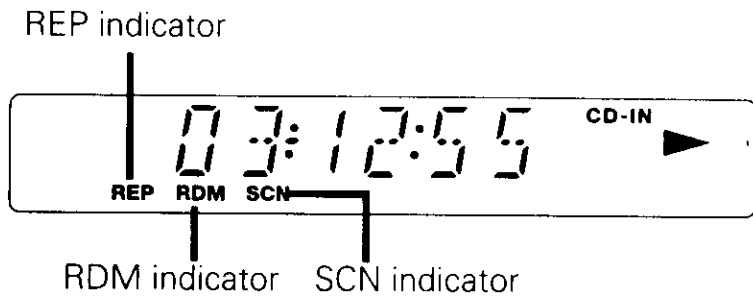
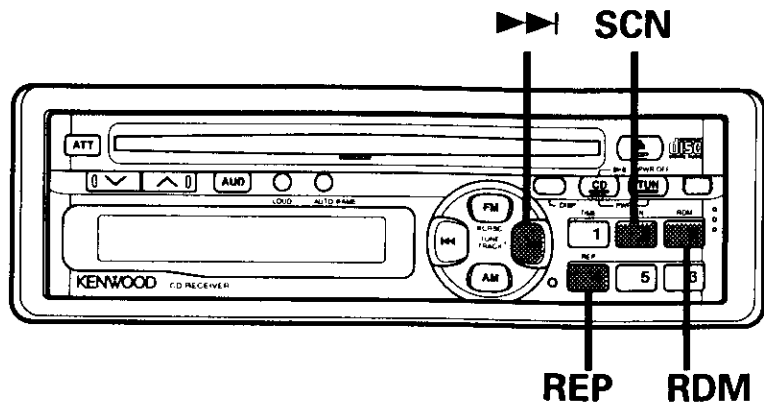

Track Repeat

Repeat playing the track currently being listened to.

Turning Repeat Play On/Off:

Press the REP button to switch repeat play on and off. The REP indicator lights up when repeat play is turned on. The track number currently being heard blinks in the display.

NOTE

Repeat play is canceled when you stop playing the disc.

Track Scan

Successively play the beginning of each track on a disc until you find the track that you want to listen to.

Turning Track Scan On/Off:

Press the SCN button to switch track scan on and off. The SCN indicator lights up when track scan is turned on. The first 10 seconds of each track will be played, in order. The track number currently being heard blinks in the display.

Stopping to Listen to the Track Being Scanned:

Press the SCN button again to stop the scan and keep on listening to a track normally.

NOTE

- Track scan is canceled when you stop playing a disc.
- Track scan only scans each track on a disc once.

Random Play

Play all the tracks on the current disc in random order.

- 1** Press the RDM button to switch random play on and off. The RDM indicator lights up when random play is turned on. The track number will change over and over in the display as the next track is being selected. When the track has been selected, play will begin. The selected track number blinks in the display as it is being played.
- 2** To change the track being heard, press the ►► button. Another track will be selected and played.

NOTE

Random play is canceled when you stop playing a disc.

Other operations

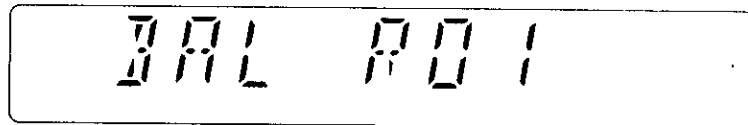
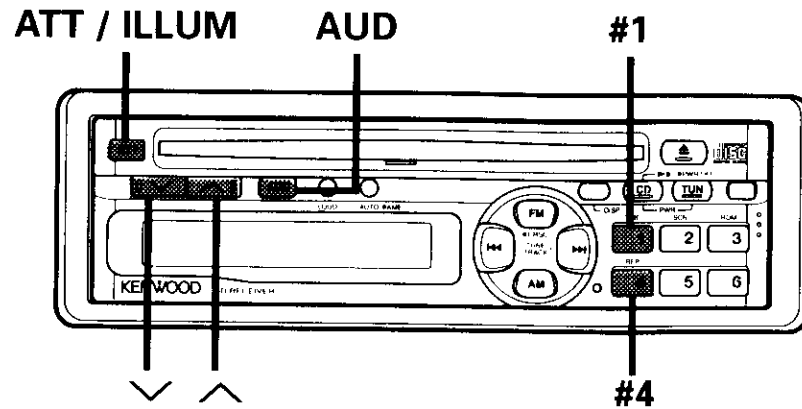

Audio Control Setting

Adjust various parameters of sound quality.

- 1 Press the AUD button to enter the control mode. Each time the AUD button is pressed, the adjustment mode display changes as follows:

→ Bass ▶ Treble ▶ Balance ▶ Fader ▶ Volume →

If you do not move to step 2 in five seconds, the tuner will switch back to the volume adjustment mode (that is the normal mode).

NOTE Source tone memory

Each source has its own memory in which to store the bass and treble tone settings. The settings made for a particular source are recalled automatically whenever you use that source (for example, disc mode uses the tone settings made for disc, FM for FM, etc.).

- 2 Press the ∨/∧ buttons to adjust the mode shown in the display. Adjust each mode according to the table on p. 19.

Other operations

Function of the KDC-5005 / 4005

Selectable Illumination

Select the colors used to illuminate the display.

Switching the illumination:

Press the ILLUM button for at least one second to switch between amber and green.

Function of the KDC-5005

Switching Preout

Switch the front preout to non-fading.

- 1 Turn off the power.
- 2 Turn the power back on holding down the #1 and #4 buttons to switch front preout to non-fading.
"nF On" is displayed when non-fading is selected.
When non-fading is selected, the high-path filter is automatically applied to the speaker output.

Repeat steps 1 and 2 to switch back to front preout.

Adjustment mode (Display)	Operation of Audio control button	
	∨ button	∧ button
Bass ("BAS")	Bass decreased	Bass increased
Treble ("TRE")	Treble decreased	Treble increased
Balance ("BAL")	Left channel emphasized	Right channel emphasized
Fader ("FAd")	Rear channel increased	Front channel increased

Other operations

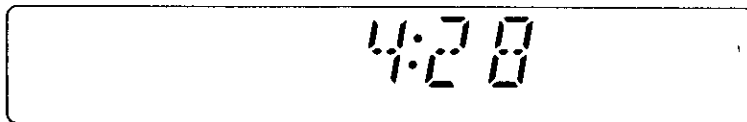
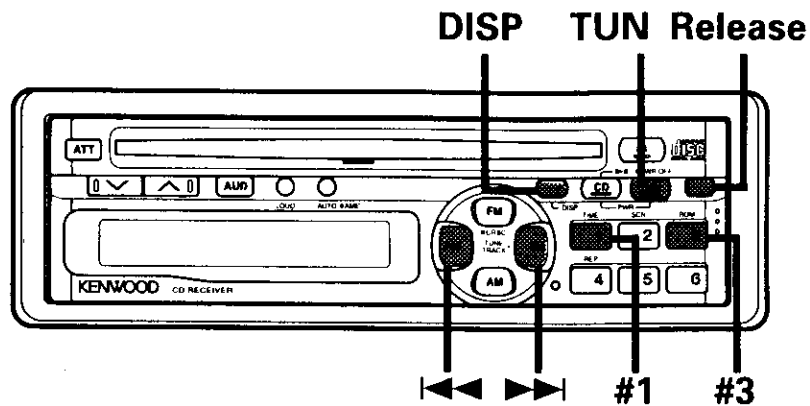

Clock Display

Displays the time.

Switching to Time Display:

Press the DISP button to display the time.

Adjusting Time

Adjust the time.

- 1 When the time is not displayed, first press the DISP button to display the time.
- 2 While holding down the DISP button, press the ◀◀ or ▶▶ buttons to adjust the time. The ◀◀ button adjusts the hour and the ▶▶ button adjusts the minutes.

Function of the KDC-5005 / 4005 / 3005

Disabled System Indicator (DSI)

A red indicator will blink on the unit after the faceplate is removed, warning potential thieves. The factory default for this function is ON.

Canceling DSI:

- 1 Turn the power of the unit off.
- 2 Simultaneously press the #1 and #3 buttons as you turn the power back on.

Repeat steps 1 and 2 above to turn DSI back on.

Function of the KDC-5005 / 4005 / 3005

Theft Deterrent Faceplate

The faceplate of the unit can be detached and taken with you, helping to deter theft.

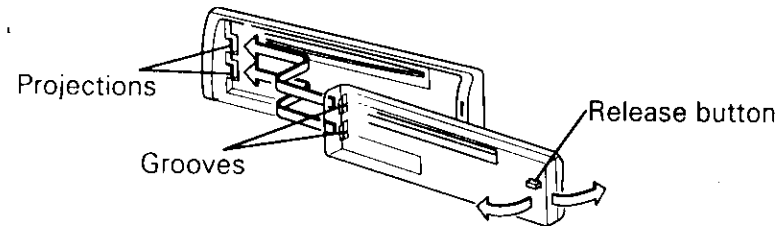

Removing the Faceplate:

Press the release button.
The faceplate is unlocked, allowing you to detach it.

NOTE

- The faceplate is a precision piece of equipment and can be damaged by shocks or jolts. For that reason, keep the faceplate in its special storage case while detached.

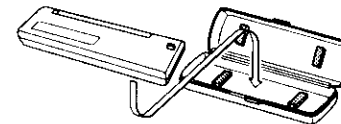





- Do not expose the faceplate or its storage case to direct sunlight or excessive heat or humidity. Also avoid places with too much dust or the possibility of water splashing.

Reattaching the Faceplate:

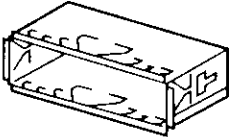
- 1 Align the projections on the unit with the grooves on the faceplate.
- 2 Push the faceplate in until it clicks.
The faceplate is locked in place, allowing you to use the unit.

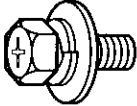
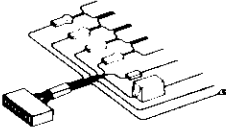
Accessories

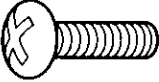
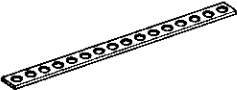
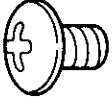
External view	Part name	Number of items	External view	Part name	Number of items	External view	Part name	Number of items
	Mounting sleeve	1		Removal tool	2		Hex-head machine screw with washer (M4x8)	1
	Wiring harness	1		Phillips flush head self tapping screw (ø5x8)	4		Phillips pan head screw (ø4x16) (KDC-5005 / 4005 / 3005 only)	1
	Metal mounting strap	1		Phillips truss head self tapping screw (ø5x8)	4			

CAUTION

Do not use any accessories other than those provided with your unit. If you use other accessories, you may damage the unit.

Installation Procedure

1. To prevent a short circuit, remove the key from the ignition and disconnect the \ominus battery.
2. Make the proper input and output wire connections for each unit.
3. Connect the speaker wires of the wiring harness.
4. Connect the wiring harness wires in the following order: ground, battery, ignition.
5. Connect the wiring harness connector to the unit.
6. Install the unit in your car.
7. Reconnect the \ominus battery.
8. Press the reset button.

CAUTION

- If your car's ignition does not have an ACC position, connect the ignition wires to a power source that can be turned on and off with the ignition key. If you connect the ignition wire to a power source with a constant voltage supply, as with battery wires, the battery may die.
- If the fuse blows, first make sure the wires aren't touching to cause a short circuit, then replace the old fuse with one with the same rating.
- Do not let unconnected wires or terminals touch metal on the car or anything else conducting electricity. To prevent a short circuit, do not remove the caps on the ends of the unconnected wires or the terminals.
- Connect the speaker wires correctly to the terminals to which they correspond. The unit may receive damage or fail to work if you share the \ominus wires or ground them to any metal part in the car.
- After the unit is installed, check whether the brake lamps, blinkers, wipers, etc. on the car are working properly.
- Insulate unconnected wires with vinyl tape or other similar material.

Connecting Wires to Terminals (KDC-5005)

NOTE Circled numbers indicate the steps described in the installation procedure.

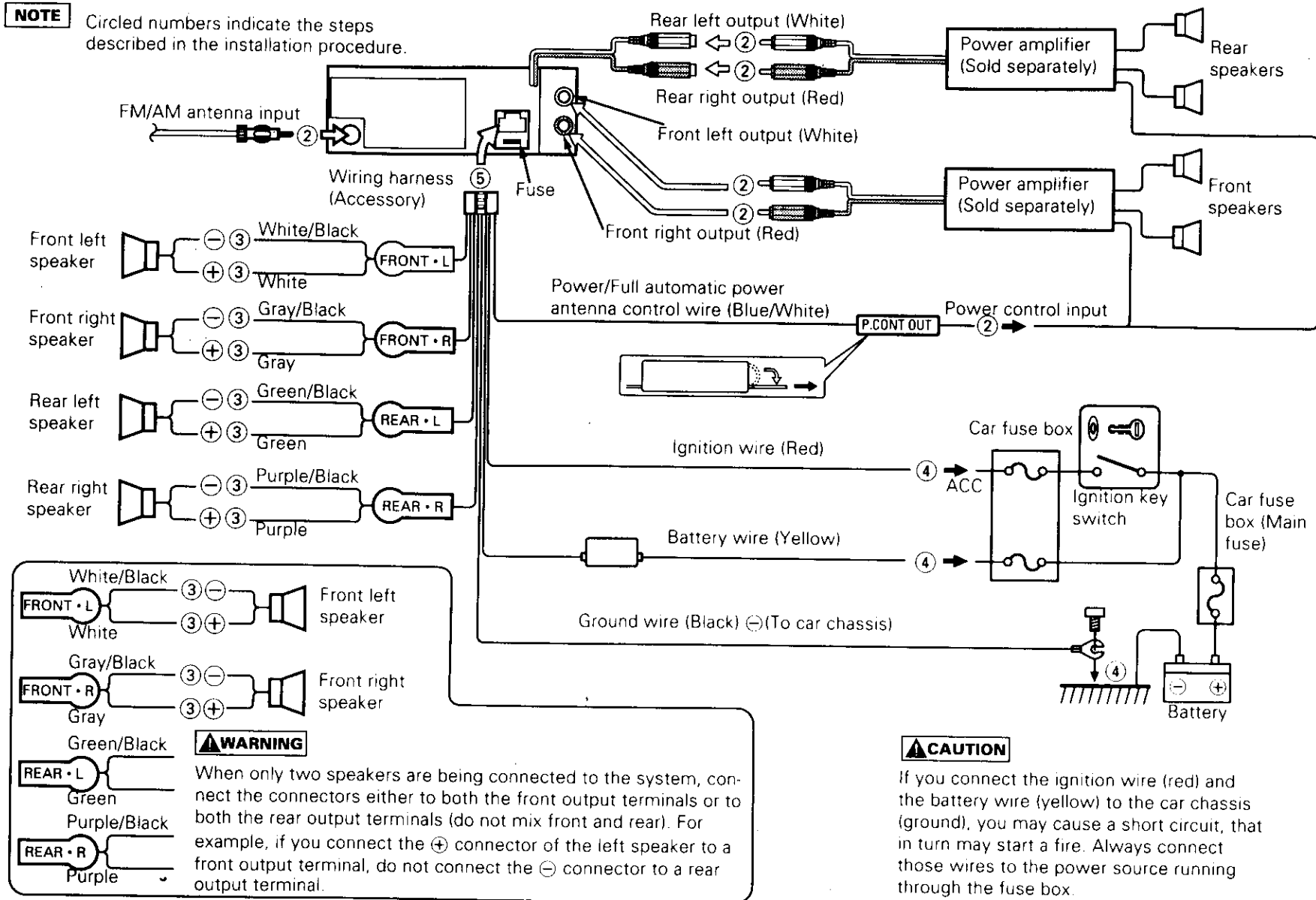

Connecting Wires to Terminals (KDC-4005 / 3005 / 2006)

NOTE Circled numbers indicate the steps described in the installation procedure.

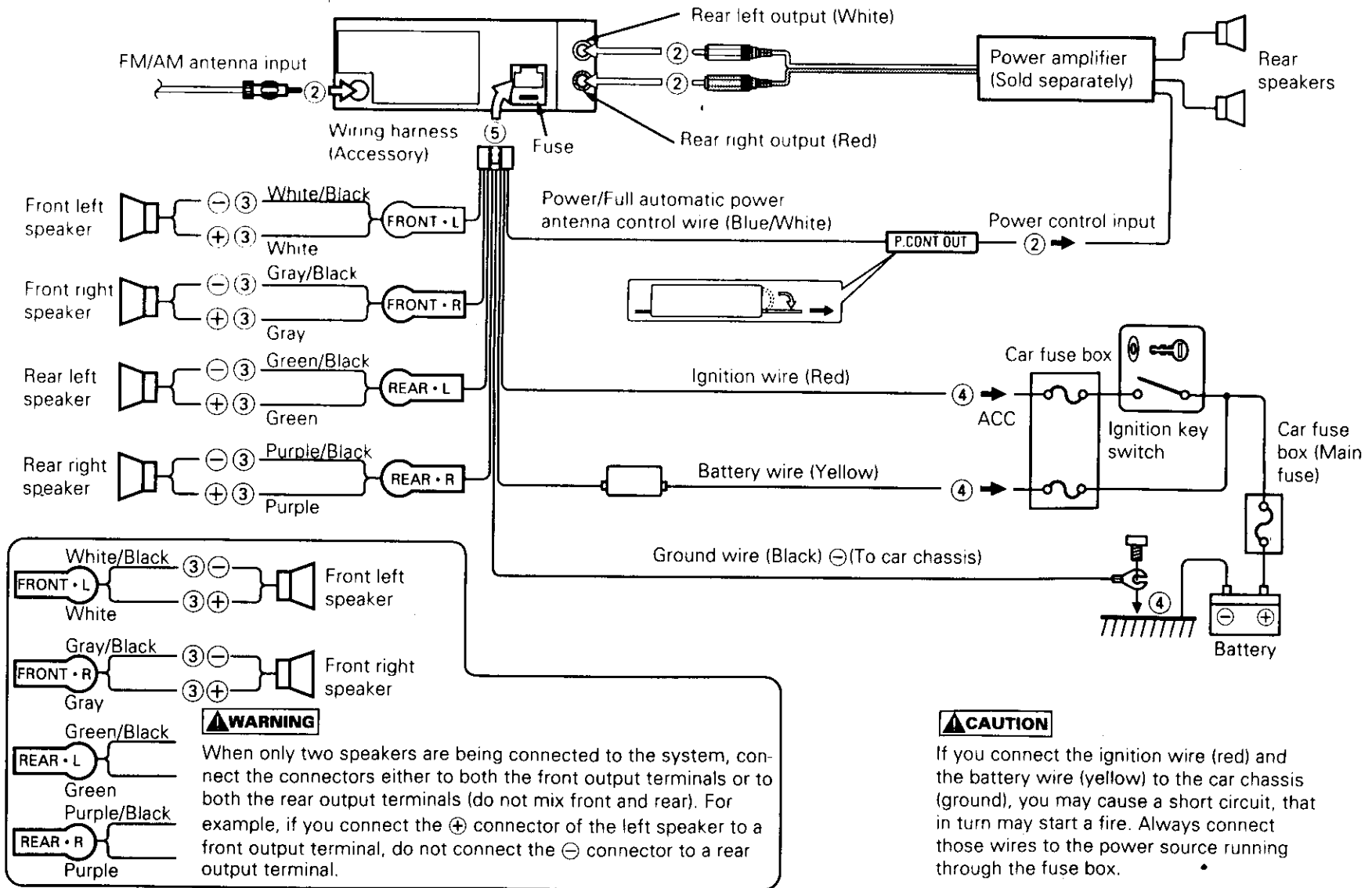

Installation

■ Installation

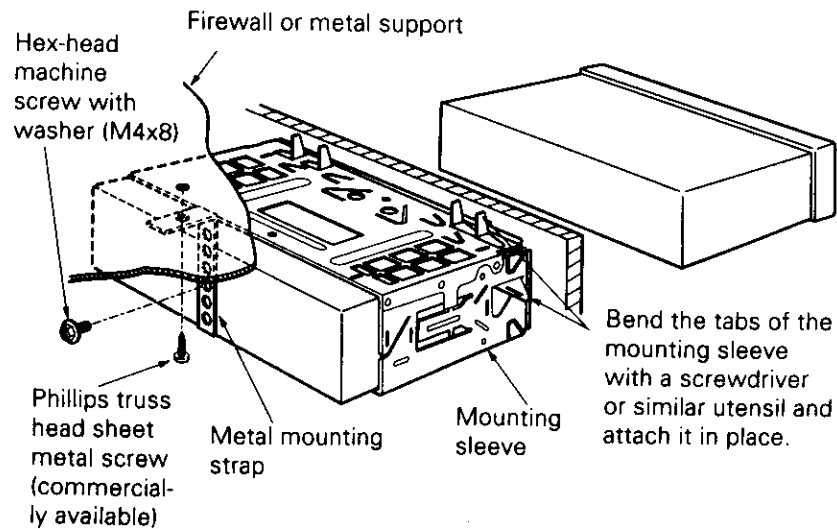

NOTE

Make sure that the unit is installed securely in place. If the unit is unstable, it may malfunction (for example, the sound may skip).

■ Removing the hard rubber frame

- 1 Engage the catch pins on the removal tool and remove the two locks on the lower level. Lower the frame and pull it forward as shown in the figure.

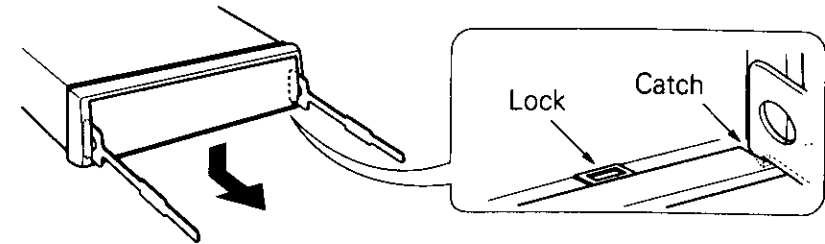

- 2 When the lower level is removed, remove the upper two locations.

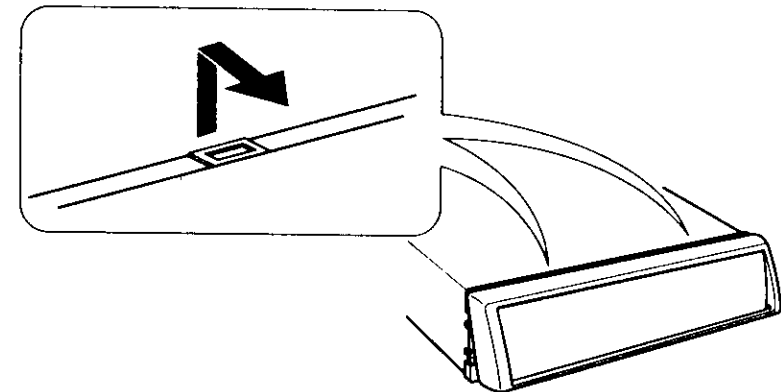

NOTE

The frame can be removed from the top side in the same manner.

■Removing the Unit

- 1 Refer to the section "Removing the hard rubber frame" and then remove the hard rubber frame.
- 2 Remove the hex head machine screw with washer (M4x8) on the back panel.
- 3 Insert the two removal tools deeply into the slots on each side, as shown.

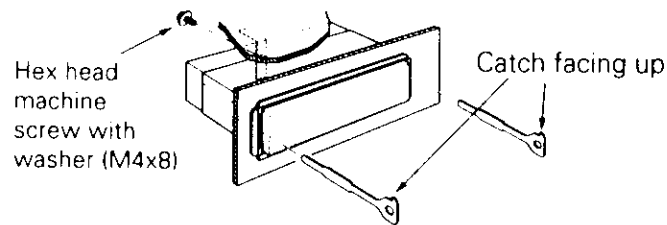

- 4 Lower the removal tool toward the bottom, and pull out the unit halfway while pressing towards the inside.

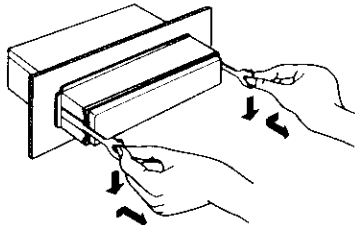

▲CAUTION

Be careful to avoid injury from the catch pins on the removal tool.

- 5 Pull the unit all the way out with your hands, being careful not to drop it.

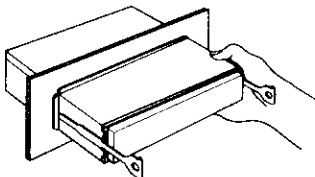

■Screwing the Faceplate on the Unit

If you want to fasten the faceplate to the main unit so that it does not fall off, insert the provided screw (ø4 x 16mm) in the hole shown below.

Phillips pan head screw (ø4 x 16)

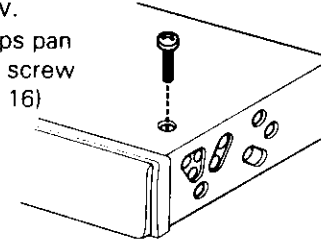

▲CAUTION

Never insert the phillips pan head screw (ø4 x 16mm) in any other screw hole than the one specified. If you insert it in another hole, it will contact and may cause damage to the mechanical parts inside the unit.

■Installing in Japanese-Made Cars

- 1 Refer to the section "Removing the hard rubber frame" and then remove the hard rubber frame.
- 2 Align the holes in the unit (two locations on each side) with the vehicle mounting bracket and secure the unit with the accessory screws.

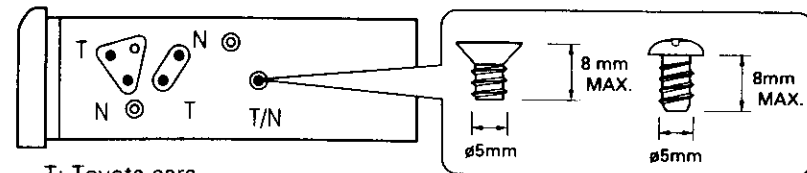

▲CAUTION

- Do not use your own screws. Use only the screws provided. If you use the wrong screws, you could damage the unit.
- Damage may occur if a screwdriver or similar tool is used with excessive force during the installations.

Troubleshooting Guide

What might appear to be a malfunction in your unit may just be the result of slight misoperation or miswiring. Before calling service, first check the following table for possible problems.

PROBLEM	POSSIBLE CAUSE	SOLUTION
The power does not turn on.	The fuse has blown.	After checking for short circuits in the wires, replace the fuse with one with the same rating.
No sound can be heard, or the volume is low.	The volume has been turned all the way down.	Turn up the volume.
	Attenuator is turned on.	Turn off Attenuator.
	The fader or balance settings are set all the way to one side.	Reset the fader or balance settings.
	The input/output wires or wiring harness are connected incorrectly.	Reconnect the input/output wires or the wiring harness correctly. See the section on "Connecting Wires to Terminals".
Nothing happens when the buttons are pressed.	The computer chip in the unit is not functioning normally.	Press the reset button on the unit (see p. 4).
The sound quality is poor or distorted.	The volume is too high.	Turn down the volume
	One of the speaker wires is being pinched by a screw in the car.	Check the speaker wiring
	A speaker wire is being shared by two speakers	Reconnect the speaker wires so that each output terminal is connected to a different speaker
Radio reception is poor	The car antenna is not extended.	Pull the antenna out all the way
	The antenna control wire is not connected	Connect the wire correctly, referring to the section on "Connecting Wires to Terminals"

PROBLEM	POSSIBLE CAUSE	SOLUTION
The memory is erased when the ignition is turned off	The battery wire has not been connected to the proper terminal	Connect the wire correctly, referring to the section on "Connecting Wires to Terminals".
A CD cannot be loaded	A second CD has already been loaded	Eject the CD in the unit and load another.
A CD ejects as soon as it is loaded	The CD is upside down	Load the CD with the labeled side up.
	The CD is quite dirty	Clean the CD, referring to the section on "Cleaning CDs" (see p. 6).
The sound skips on a CD	The CD is scratched or dirty	Clean the CD, referring to the section on "Cleaning CDs" (see p. 6).
	The sound recorded on the CD is itself poor	Try another disc for comparison. If it is alright, the first disc was bad.
The sound quality of the CD is poor	The disc is scratched or dirty	Clean the CD, referring to the section on "Cleaning CDs" (see p. 6).
	Random play has been selected.	Turn off random play.
A track will not play.	Random play has been selected.	Turn off random play.

Specifications

Specifications subject to change without notice.

FM tuner section

Frequency range	87.9 MHz ~ 107.9 MHz
Channel space	200 kHz
Usable sensitivity (S/N = 30dB)	9.3dBf (0.8 μ V/75 Ω)
Quieting Sensitivity (S/N = 50dB)	15.2dBf (1.6 μ V/75 Ω)
Frequency response (\pm 3.0 dB)	30 Hz – 15 kHz
Signal to Noise ratio (MONO)	75 dB
Selectivity (\pm 400 kHz)	\geq 80 dB
Image Response Ratio	70 dB
IF Response Ratio	120 dB
Stereo separation (1 kHz)	40 dB

AM tuner section

Frequency range	530 kHz ~ 1700 kHz
Channel space	10 kHz
Usable sensitivity	28 dB (25 μ V)

CD player section

Laser diode	GaAlAs (λ =780 nm)
Digital filter (D/A)	8 Times Over Sampling
D/A Converter	1 bit
Spindle speed	500 ~ 200 rpm (CLV)
Wow & Flutter	Below Measurable Limit
Frequency response (\pm 1 dB)	10 Hz ~ 20 kHz
Total harmonic distortion (1 kHz)	0.01 %
Signal to Noise ratio (1 kHz)	93 dB
Dynamic range	93 dB
Channel separation	85 dB

Audio section

Maximum output power	
KDC-5005/4005:	35 W \times 4
KDC-3005/2006:	30 W \times 4
Full bandwidth power (at less than 1% THD)	
KDC-5005/4005:	20 W \times 4
KDC-3005/2006:	18 W \times 4
Tone action	
Bass:	100 Hz \pm 10 dB
Treble:	10 kHz \pm 10 dB
Preout level / Load	1800 mV (Max.) / 10 k Ω
Preout Impedance	\leq 600 Ω

General

Operating voltage	14.4 V (11 ~ 16 V allowable)
Current consumption	10.0 A at Rated power
Installation size (W \times H \times D)	182 \times 53 \times 164 mm
	7-3/16 \times 2-1/16 \times 6-7/16 in.
Weight	1.5 kg
	3.3 Lbs